



# FM STEREO TUNER

# MR 71

## TABLE OF CONTENTS

## CONTENTS

INTRODUCTION	1
TECHNICAL DESCRIPTION	2
FRONT PANEL INFORMATION	6
BACK PANEL INFORMATION	8
INSTALLATION	8
CONNECTING	9
Audio Outputs	9
Stereophonic FM Multiplex	9
Monophonic FM	9
Remote Amplifiers	9
Off-The-Air Recording	9
Antenna Connections	9
OPERATING INSTRUCTIONS	11
Stereophonic FM Multiplex	11
Monophonic FM	11
ADJUSTMENTS	12
Muting Threshold	12
Dial Panel Lights	12
Output Adjust	12
GUARANTEE	13



# OWNER'S MANUAL



# THANK YOU

Judging from the stereo equipment you own, you rank high among discriminating music listeners. You are probably no freshman when it comes to stereo. Never-the-less we ask you to read and carefully follow these instructions to insure a successful partnership between you and your new stereo equipment.

You now have "THE BEST." Used properly you are in for thousands of hours of musical enjoyment.

If you are in a hurry, read page 3 first. This gives you a brief outline of what each control and indicator does. Reading time for this manual is 30 minutes. This is time well spent.

## MR 71 FM STEREO TUNER

### INTRODUCTION

The McIntosh MR 71 is a precision engineered, highly sensitive FM Multiplex Tuner.

The research staff of McIntosh Laboratory has developed five new tuner circuit improvements for the MR 71.

1. Automatic stereo-mono switching that is "clickless" and completely electronic. (Patent applied for.)
2. Multipath indicator to eliminate multipath reception by showing when your antenna is rotated to the correct position for minimum multipath distortion.
3. Double tuned input circuits before the first R.F. amplifier to reduce spurious responses.
4. New D'Arsonval movement meters of increased sensitivity which do not need zero setting adjustments.
5. A new computer designed filter to reduce noise from stations broadcasting sub-carrier auxiliary music services. No other tuner uses such a filter.

The MR 71 also uses the exclusive McIntosh PANLOC method of installation. The PANLOC system gives you absolute ease of installation, operation, and maintenance.

PANLOC is the first professional installation technique to be used on stereo instruments.

In the PANLOC system a metal shelf is mounted first. The tuner slides into position on this shelf. Depressing the PANLOC buttons on the front panel locks the tuner firmly into place for normal operation. To unlock the tuner depress the PANLOC buttons a second time. The tuner can now slide from the front panel. The tuner will lock into this position, preventing accidental release of the tuner from the installation. Depressing the holding latches allows the tuner to be taken out of the PANLOC shelf or to slide back into position against the mounting panel.

The finest possible reception of FM monophonic and FM multiplex stereophonic broadcasts is assured by the McIntosh MR 71 tuner.

Once you have enjoyed the outstanding performance of the MR 71, you will understand why McIntosh products have earned their reputation as "THE BEST." Your McIntosh MR 71 tuner will give you years of the finest possible FM reception, and will be a valued part of your home music system.

## TECHNICAL DESCRIPTION

The MR 71 tuner has a 6DS4 high-grain Nuvistor for the first RF amplifier. The Nuvistor (triode) operates into a second triode tube to form a cascade amplifier. Careful design of the operating characteristics allows the cascade amplifier to handle a wide dynamic range of signals with excellent signal-to-noise ratio.

A double-tuned RF input circuit combined with the Nuvistor-tube cascade amplifier reduces spurious signals to an extremely low value. Sensitivity is increased to the highest possible rating, while still retaining high selectivity.

A newly developed Automatic Frequency Control (AFC) circuit greatly simplifies tuning. As the tuning knob is moved, the AFC circuit automatically cuts off for sharpest tuning. After the station is tuned in, the AFC circuit gradually comes into operation over a 3 second interval. The AFC action automatically brings the tuning to minimum distortion. This automatic tuning repeats its action each time the tuning dial is moved to a new station. The amount of AFC action is fully adjustable with a front panel control.

The AFC circuit is unique. It uses a silicon diode in place of a conventional tube. The silicon diode improves the overall AFC performance. It is unaffected by temperature changes. It has no warm-up drift and eliminates the chance of tube filament hum. A temperature-compensated narrow band detector supplies operating signals to the AFC circuit. This insures positive AFC action. The narrow band detector also operates the FM tuning meter amplifier and the ultrasonic muting circuit.

The McIntosh developed ultrasonic muting circuit automatically suppresses all interstation noise, including the noises usually heard tuning in and out of a station. Weak or distant stations that can't override the background noise and interference are suppressed by the muting. A front panel switch allows muting to be cut off for listening to weak and noisy stations. A back panel adjust control is factory set to the correct muting threshold level.

The mixer output is amplified through five intermediate frequency stages with flat-topped highly selective response curves. The IF transformers have wide band response with maximum adjacent channel rejection. Construction of the IF transformers assures electrical stability and resistance to mechanical shock and vibration. More than adequate gain is provided to operate both limiters on the weakest signals. Two complete limiters are used for the best possible signal-to-noise ratio.

A separate wide band detector handles only audio frequencies for low distortion and wide frequency response.

Both the RF and IF circuits are completely shielded in excess of FCC requirements for suppression of radiation of the FM oscillator and IF frequencies.

The MR 71 multiplex decoder uses a McIntosh developed detector. The advantage of this circuit is the elimination of critical adjustments necessary with commonly used multiplex matrixing methods. The L-R (left minus right) stereo sidebands are detected. Then automatically combined with the L+R main carrier signal. The left and right channel signals are then produced with excellent separation.

A temperature stabilized 19KC amplifier locks in a highly stable 38KC synchronous oscillator. This method gives exceptional noise immunity. Balanced detectors cancel the 38KC signal components in the output, providing low distortion and reduced susceptibility to spurious signals. Tape recording interference is minimized by this method.

A highly selective computer designed filter reduces noise from stations broadcasting auxiliary music services. The filter reduces the frequency band from 63-74KC approximately 50db. The filter response slope is 275db per octave. The noise is eliminated without affecting normal program material.

The MR 71 has a multiplex stereo indicator which lights when the dial pointer crosses a station broadcasting multiplex stereo. A unique circuit using a transistor operates the

Your McIntosh MR71 tuner will give you many years of pleasant and satisfactory performance. If you have any questions concerning the operation or maintenance of this tuner please contact:

Customer Service  
McIntosh Laboratory Inc.  
2 Chambers Street  
Binghamton, New York  
Our telephone number is 723-5491.  
The direct dial area code is 607.

### **GUARANTEE**

McIntosh Laboratory Incorporated guarantees this equipment to perform as advertised. We also guarantee the mechanical and electrical workmanship and components of this equipment to be free of defects for a

period of 90 days from date of purchase. This guarantee does not extend to components damaged by improper use nor does it extend to damage incurred during transportation to and from McIntosh Laboratory, Inc.

### **3-YEAR FACTORY SERVICE CONTRACT**

An application for a FREE 3-YEAR FACTORY SERVICE CONTRACT is included in the pocket in the back cover of this manual. The FREE 3-YEAR FACTORY SERVICE CONTRACT will be issued by McIntosh Laboratory upon receipt of the completely filled out application form. The term of this contract is de-

finied in the 3-year factory service contract. If the application is not mailed to McIntosh Laboratory, only the services offered under the standard 90-day guarantee will apply on this equipment. TAKE ADVANTAGE OF 3 YEARS OF FREE FACTORY SERVICE BY FILLING IN THE APPLICATION NOW.

MPX stereo indicator lamp. The transistor is controlled by a noise-rejecting differential detecting bridge circuit. The circuit discriminates between noise and the 19KC multiplex pilot signal. The indicator will light only on the 19KC signal present in a multiplex stereo broadcast.

The MR 71 uses a new McIntosh developed automatic mono-stereo switching circuit. (Pat. Pend.) The switching is electronic without switching clicks or transients.

The circuit switches smoothly and silently when the 19KC multiplex carrier is present.

The multipath signal indicator on the tuning dial is an electron ray tube. This is an exclusive McIntosh development. Multipath signal reception causes moderate to severe distortion and poor stereo channel separation. By knowing the presence of multipath reception, a directional FM antenna may be rotated to reduce or eliminate the multipath signal. The MR 71 multipath indicator shows

if there are multipath signals present by rapid fluctuation of the electron ray beams.

With the antenna correctly positioned, the indicator beams remain relatively steady, showing that multipath distortion has been eliminated.

Two pairs of audio output jacks are on the back panel. One pair of jacks is controlled only by the front panel volume control. The other pair of jacks is controlled only by the back panel output adjust controls. Two stage feedback type preamplifiers on both channels provide low impedance outputs. More than sufficient output volume is available to feed power amplifiers as well as preamplifiers.

A new type of mechanical tuning assembly gives the MR 71 extremely smooth flywheel tuning action. The tuning capacitor is driven directly, and in turn drives the pointer. Backlash is eliminated with this design. A teflon lined pointer carriage and nylon pulleys reduce friction and wear to give an unusually smooth and quiet dial action.

## IF YOU ARE IN A HURRY

Turn antenna so the eye is steady.

Will light only on stations broadcasting MPX stereo,

Tuning . . . select desired station

Adjust to desired volume.

Tune for Max. reading.

Power off. Use stereo-auto position: will switch automatically from stereo to mono.

Continuously variable, use Max. position for MPX reception.

Tune for center of black area.

In . . . eliminates interstation noise. Out . . . use to receive weak stations.

## SPECIFICATIONS

### Useable Sensitivity

2.5 microvolts at 100% modulation ( $\pm 75$ KC deviation) for less than 3% total noise and harmonic distortion in accordance with IHF standards.

### Audio Frequency Response

Within  $\frac{1}{2}$ db from 20 to 20,000 cycles.

### Distortion

Less than 0.5% at 100% modulation  $\pm 75$ KC deviation

### Capture Ratio

1.5db at 100% modulation.

### Muting

IF injected ultrasonic muting: at least 60db noise reduction between stations.

### Oscillator Drift

Less than 25KC with AFC disabled; negligible with AFC in operation.

### Image Rejection

Better than 80db at 90MC; better than 70db at 105MC.

### Hum

Better than 70db below 100% modulation.

### Output

Approximately 2.5 volts; low impedance.

### Antenna Inputs

300 ohms balanced; 75 ohms unbalanced.

### RF Amplifier

Cascode with 6DS4 Nuvistor in first stage.

### IF Stages

Five, with 200KC bandwidth, flat top response.

### Limiters

Two.

### Radiation

Substantially below FCC requirements.

### Multiplex Channel Separation

Better than 30db at 1000 cycles.

### Multiplex Filter

Greater than 48db suppression of 19KC pilot and 38KC carrier.

### Multiplex Indicator

Front panel multiplex stereo light activated by 19KC carrier-only.

### Multiplex Type

Peak-detecting, self matrixing detector.

### SCA Filter

50db down at 67KC to 74KC 275db per octave slope.

### Automatic Mono-Stereo Switch

An exclusive McIntosh development; all-electronic automatic mono-stereo switching circuit. (Pat. Pend.).

### Tube and Semiconductor Complement

1-6DS4 Nuvistor, 1st RF.  
1-12AT7, 2nd RF and Mixer.  
1-6BN4A, Oscillator.  
1-6AU6, 1st IF.  
1-6AU6, 2nd IF.  
1-6AU6, 3rd IF.  
1-6AU6, 4th IF and 1st Limiter.  
1-6CS6, 5th IF 2nd Limiter and Muting.  
1—6BN8, Muting Amplifier, Muting Detector, AVC Clamper.  
2-6BL8, Left and Right, 1st and 2nd Audio Amplifiers.  
1-6U8, MPX Amplifier, MPX Indicator Control.  
1-6HU6/EM87 Multipath Indicator.  
1-12AU7, MPX Oscillator.  
1-ST2-275, Voltage Reference.  
1-MA113 (Transistor), MPX Indicator Lamp Switch.  
2-1N542 Diodes, Wide Band Discriminator.  
2—1N542 Diodes, Narrow Band Discriminator.  
4-1N542 Diodes, Balanced MPX Detector.  
2-1N542 Diodes, Balanced Detector for MPX Indicator.  
2—Selenium Rectifiers, High Voltage Power Supply.  
1-No. 1850 Lamp, MPX Indicator.

### Power Consumption

70 watts, 105 to 125 volts, 50 to 60 cycles.

### Dimensions

Front Panel; 16 inches wide by  $5\frac{7}{16}$  inches high; chassis (including PANLOC shelf) 15 inches wide by 5 inches high by 13 inches deep, including connectors; clearance in front of mounting panel including knobs.  $1\frac{1}{2}$  inches.

### Weight

Chassis only, 27 pounds.  
In shipping carton, 37 pounds.

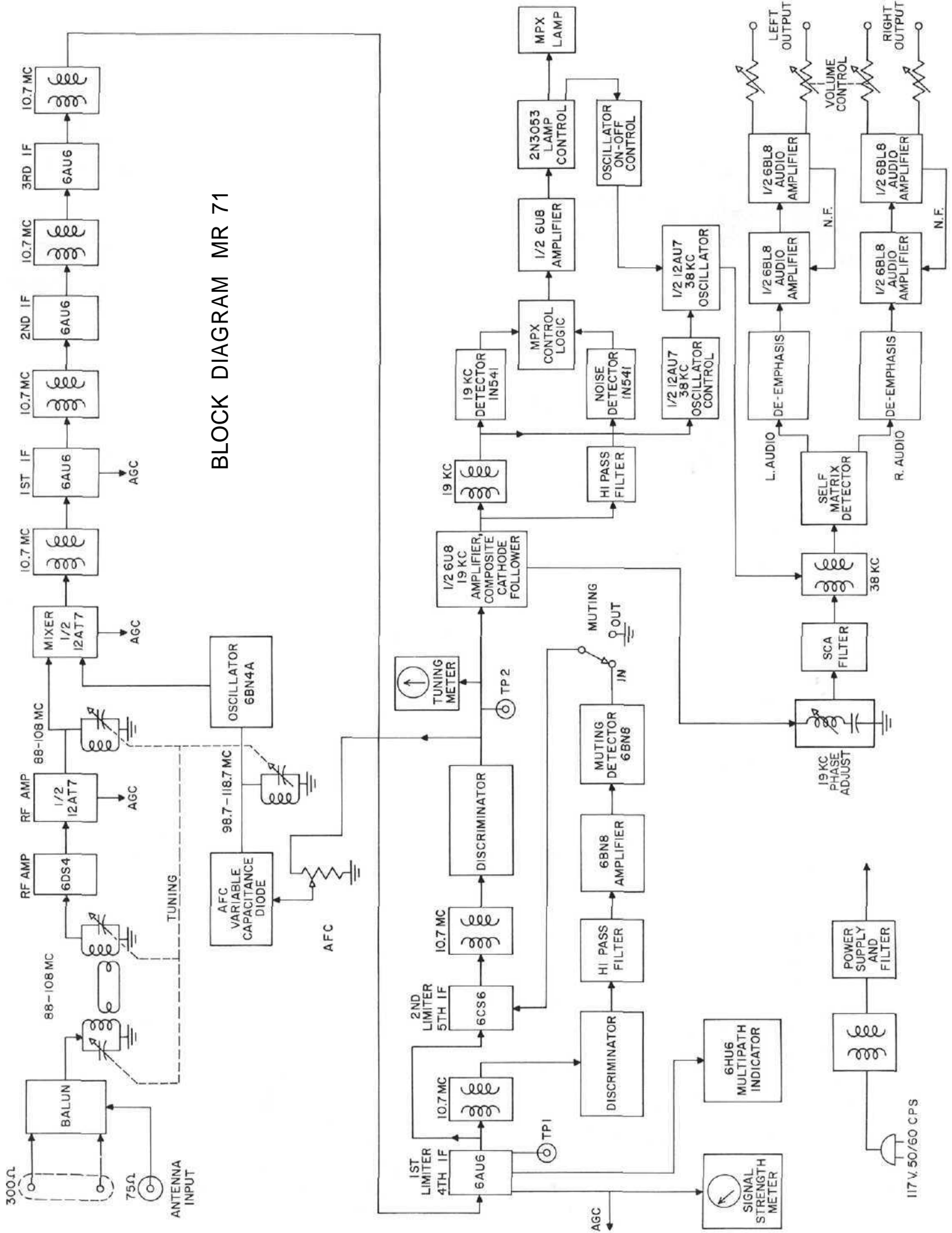

BLOCK DIAGRAM MR 71



## FRONT PANEL INFORMATION



### TUNING DIAL SCALES

The MR 71 has two dial scales, the 88 to 108 scale marked in megacycles and the 0-100 logging scale. The dial scale marked in megacycles indicates the positions of FM stations in the 88 to 108 megacycle band. The logging scale with linear divisions from 0-100 is located directly beneath the 88 to 108 scale. The logging scale can be used to accurately retune any station. You may find it easier to keep a record of your favorite stations by use of the logging scale.

### INDICATORS

The MR 71 has four indicators on the dial panel: MULTIPATH indicator, SIGNAL STRENGTH indicator, STEREO indicator, and the TUNING indicator.

### MULTIPATH INDICATOR

The MR 71 MULTIPATH indicator is an exclusive McIntosh development.

The MR 71 MULTIPATH indicator makes it possible to improve FM reception with precise FM antenna positioning.

Reduce noise due to multipath reception.

Reduce distortion due to multipath reception.

Improve stereo separation and the accuracy of your STEREO INDICATOR by reducing multipath reception.

The MR 71 MULTIPATH INDICATOR shows distortion from multipath signal reception. Multipath reception causes the two beams on the indicator to fluctuate rapidly. When the antenna is rotated to the correct position, the indicator beams will remain steady. The

directional antenna is picking up only the desired signal and rejecting the reflected multipath signals. In some locations, it is possible that the best reception will occur on a strong reflected signal rather than the direct signal. When you tune to a different station, the multipath indicator will tell you if multipath is present. Multipath is independent of signal strength.

### STEREO INDICATOR

The stereo indicator will light when the dial pointer crosses a station broadcasting multiplex stereo. The special circuit used will light ONLY on the 19KC multiplex carrier. The indicator will not light on noise pulses or interference.

### TUNING INDICATOR

An FM station is correctly tuned when the indicator is in the black area of the tuning indicator. The action of the TUNING indicator is independent of station signal strength.

### VOLUME

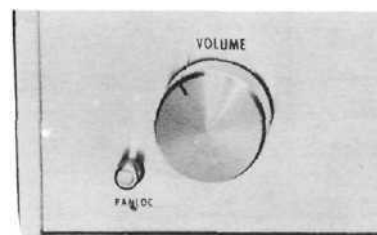

Controls volume level when the tuner is connected to the pair of jacks marked FRONT PANEL CONTROLLED.

## MODE SELECTOR POWER OFF

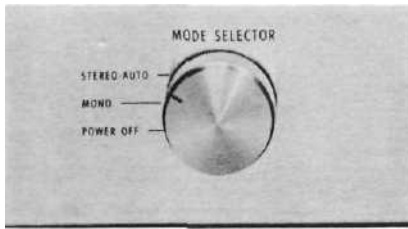

Turns off the tuner AC power and the AC outlet on the tuner back panel.

## MONO

Provides monophonic FM at both pairs of left and right channel audio output jacks.

## STEREO AUTO

The STEREO AUTO position provides both monophonic FM and FM multiplex stereo at the left and right channel audio output jacks. Assume you have the MR 71 MODE SELECTOR in the STEREO AUTO position. You are listening to a station broadcasting FM monophonic. The station switches to MPX stereo broadcast. The MULTIPLEX indicator will light. The MR 71 will automatically switch to FM multiplex stereo operation. If mono broadcasting is resumed the MR 71 will automatically switch to FM monophonic.

## AUTO FREQ. CONTROL



The Automatic Frequency Control (AFC) circuit makes FM tuning easier. It eliminates the possibility of tuner drift. The AFC circuit in the MR 71 is electronically delayed in its action. This is an exclusive McIntosh development. When the tuning dial is moved, the AFC circuit is temporarily cut off. When the dial pointer comes to rest on a station the AFC gradually comes into operation. This takes three seconds. The AFC automatically

brings the tuning to minimum distortion. The AFC action repeats itself each time the tuning dial is moved to a different station.

The amount of AFC action is adjustable with the AUTO FREQ. CONTROL. Full left (MIN) position of the control cuts off AFC action. Full right (MAX) position gives maximum AFC action.

Normally, the best tuning occurs with the AUTO FREQ. CONTROL set at or near MAX position. If several stations are very close together on the dial, or if a desired station is very close to a much stronger station, a lower AFC setting is usually needed for best tuning.

## MUTING

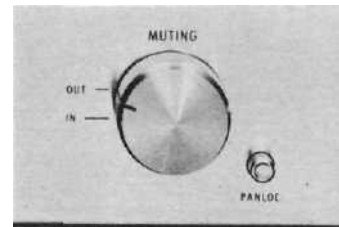

## OUT

OUT—This position turns off the muting to allow conventional tuning with interstation noise present. Use this setting to listen to weak or distant stations that have noise or interference.

IN—This position turns on the muting circuit. Muting suppresses all background hiss and noise usually heard when tuning between stations. Weak or distant stations that cannot override the background noise and interference are suppressed by the muting.

## PANLOC BUTTONS

At the bottom of the front corners are the PANLOC buttons. After a tuner is installed on the PANLOC shelf, depressing the PANLOC buttons will lock the tuner firmly in position. Depressing the PANLOC buttons a second time (as with a ball-point pen) will release the tuner. The tuner can then be slid forward to the inspection and adjustment position. The PANLOC system gives you absolute ease of installation, operation and maintenance.

## BACK PANEL INFORMATION

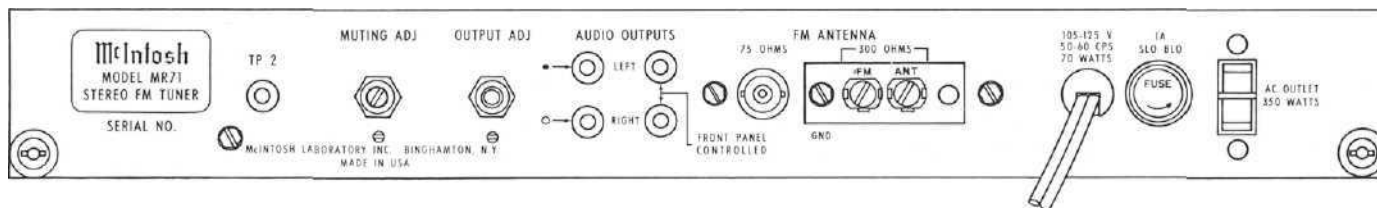

### TP 2

Test point TP 2 is provided for tuner circuit alignment. It is also used in conjunction with the McIntosh MI 2 or MI 3.

### OUTPUT ADJ

This dual concentric control adjusts the output volume levels at the left-hand pair of AUDIO OUTPUT JACKS. The center shaft adjusts the LEFT channel output, and the outer sleeve adjusts the RIGHT channel output. These output control settings for the left pair of jacks are not affected by the MR 71 front panel volume control.

### MUTING ADJ

Adjust the operating threshold of the ultrasonic muting circuit.

### AUDIO OUTPUT-LEFT-RIGHT

The left-hand pair of AUDIO OUTPUT jacks provides audio signals unaffected by the MR 71 front panel VOLUME control. The dual concentric OUTPUT ADJUST controls set the volume levels. Use these output jacks to connect the tuner to a stereo control preampli-

fier which has its own master volume control.

The right hand pair of AUDIO OUTPUT jacks provides audio signal controlled by the MR 71 front panel VOLUME control. Use these output jacks to connect to external power amplifier, tape recorders, or any equipment which requires continuous front panel control of tuner output volume.

### 300 OHM-75 OHM ANTENNA

Terminal for connecting FM antennas to the MR 71.

### 1A SLO BLO FUSE

A 1 amp "Slo-Blo" fuse protects the tuner circuits. This fuse does not protect additional equipment connected to the back panel AC outlet.

### AC OUTLET

Provides 117 volt AC power up to 350 watts maximum for additional equipment such as turntables, or other tuners. This outlet is not fused. It turns on and off with the front panel MODE SELECTOR switch.

### PANEL LIGHT SWITCH

Adjusts the panel lights to bright or dim.

## INSTALLATION

The McIntosh MR 71 tuner may be installed on a table, on a shelf, in a custom built-in cabinet, or in a professional equipment rack. For best appearance in an open installation, mount the MR 71 in the attractive McIntosh L11 cabinet. The L12 is oiled walnut. The L11 is lacquered walnut.

The MR 71 tuner is installed by the new exclusive McIntosh PANLOC method. Refer to the special PANLOC SYSTEM INSTALLATION instructions included with your MR 71.

Allow at least 13¾ inches behind the mounting panel for the MR 71 chassis. This includes clearance for leads and connectors. Allow inside dimensions of at least 16½ inches in width and 6 inches in height for adequate air circulation. The back of the MR 71 cabinet should be as open as possible for the best ventilation. Avoid mounting the tuner directly over a power amplifier. The heat from the amplifier may change the precision tuner calibration. Adequate ventilation will give your tuner long trouble-free life.

## CONNECTING

### AUDIO OUTPUTS

Use the FIXED OUTPUT jacks (left-hand pair of jacks next to OUTPUT ADJ) to connect to a conventional control preamplifier which has its own volume control. Full tuner output is available at all times from the FIXED OUTPUT jacks.

Use theFRONTPANELCONTROLLEDjacks to connect to a conventional control preamplifier when continuous front panel control of tuner volume is desired. These jacks may be used to connect to external equipment such as power amplifiers or tape recorders where control of tuner volume is necessary. There is no difference in the signal quality or output levels available at each pair of output jacks.

### STEREOPHONIC FM MULTIPLEX

Connect a shielded cable from the tuner LEFT channel AUDIO OUTPUT jack to the control preamplifier LEFT channel tuner or auxiliary input jack.

Connect a second shielded cable from the RIGHT channel tuner AUDIO output jack to the control preamplifier RIGHT channel tuner or auxiliary input jack. When the MR 71 mode selector is set to MONO or STEREO AUTO position, a monophonic broadcast will automatically be present at both left and right outputs. For a stereo broadcast set the MODE SELECTOR in the STEREO AUTO position.

### MONOPHONIC FM

The MR 71 can be used strictly for monophonic reception.

Connect a shielded cable from either the left or right audio output jack to the monophonic control preamplifier auxiliary or tuner input jack. With the MR 71 MODE SELECTOR set to MONO, the monophonic FM signal appears at both the left and right channel AUDIOOUTPUTjacks.

### REMOTE AMPLIFIERS

The pair of audio output jacks not being used in an installation may be connected to external or remote amplifiers. An FM pro-

gram can then be fed to speaker systems apart from the main sound system.

### OFF THE AIR RECORDING

Tape recorders or tape decks with record-playback preamplifiers are normally connected to the Tape Output jacks on the control preamplifier. Any FM program coming through the tuner into the preamplifier can be recorded on tape. You may also connect the extra pair of tuner audio output jacks directly to the recorder inputs if desired.

### ANTENNA CONNECTIONS

Satisfactory FM multiplex stereo reception requires 10 times as much signal as FM monophonic reception. Monophonic installations that were satisfactory with an indoor FM antenna may require an outside or directional FM antenna for satisfactory multiplex stereo reception. A good directional antenna with a rotator makes it possible to eliminate or minimize multipath distortion. The MR 71 multipath indicator shows the correct antenna position for reception with minimum multipath distortion.

### INDOOR FLEXIBLE FM DIPOLE

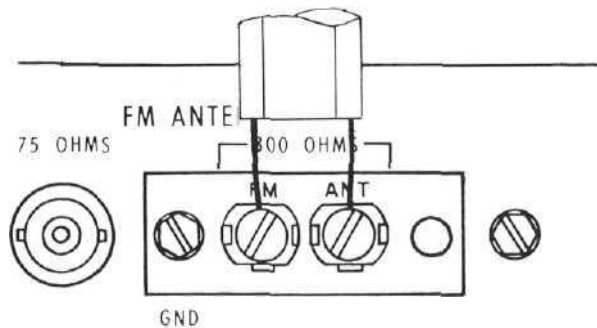

A convenient flexible indoor FM dipole (300 ohm) antenna is supplied with the MR 71 tuner. This antenna is easy to install. It is suitable for a good FM reception in high signal areas.

Connect the two leads of the dipole antenna to the two terminals marked 300 OHM on the MR 71 back panel.

The flexibility of the thin flat wire allows the dipole to be easily located behind the equipment enclosure or any position near the tuner. Open the dipole into a "T." Extend the

SEE DIAGRAM NEXT PAGE

DIRECTIONAL FM ANTENNA

ROTATOR

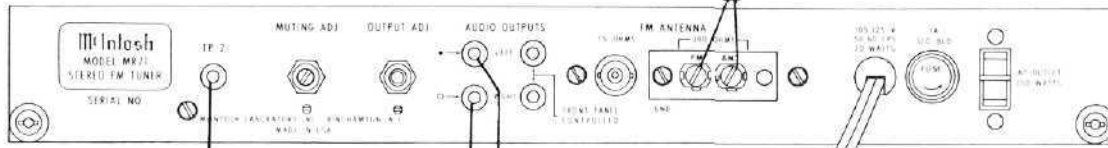

TO TP 1

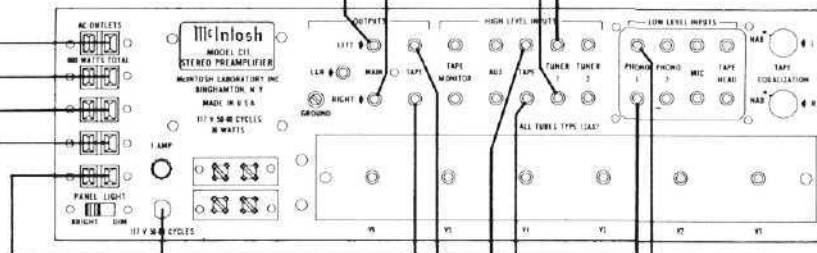
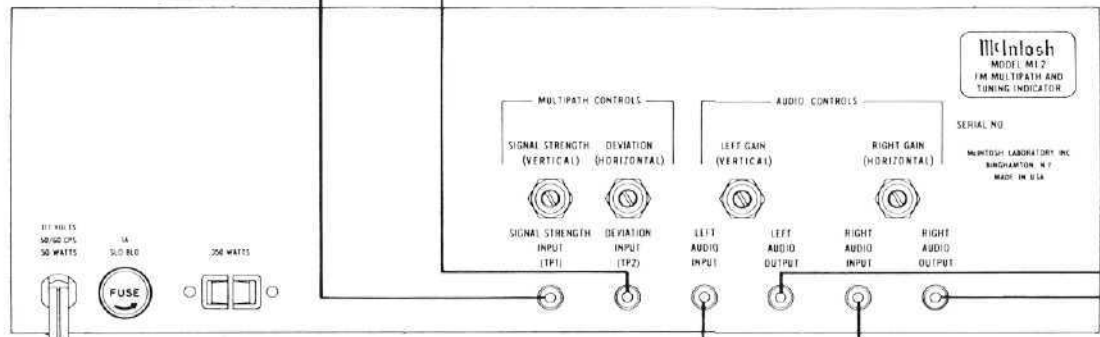

TO 117V AC OUTLET

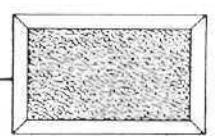
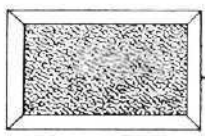
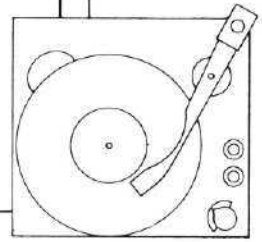
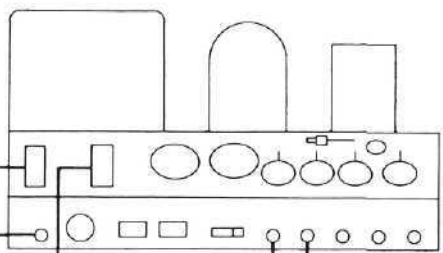
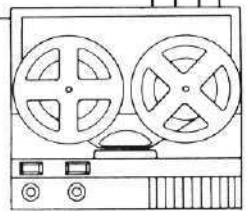

arms as straight as possible. The dipole antenna is somewhat directional. It should be positioned for best reception of the desired stations.

Experimenting with the dipole position may be necessary to reduce multipath distortion on certain stations. Since it is not convenient to continually change the position of the dipole, you may have to set it for minimum multipath on your favorite station.

### IMPORTANT

Keep the dipole away from large metal objects or surfaces. They interfere with the efficiency of the antenna.

### OUTDOOR FM ANTENNA

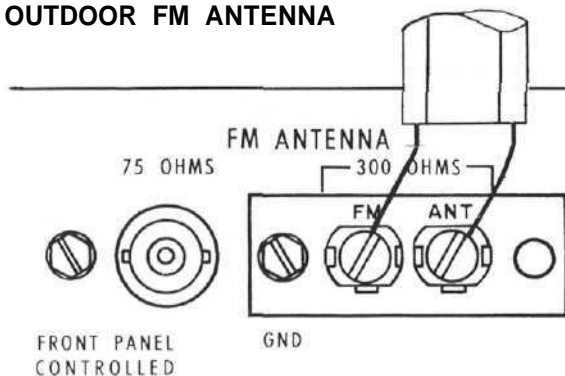

An outdoor FM antenna is recommended for best FM reception under all conditions. In fringe areas, a highly directional FM antenna used with a rotator will give the finest possible FM reception. Rotate the antenna until it points in the direction of the station or until it receives the best possible signal. Use the multipath, signal strength and tuning indicators to position the antenna correctly.

### 75 OHM ANTENNA

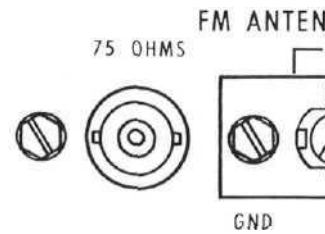

An unbalanced 75 ohm FM antenna can be used with the MR 71. A BNC connector is provided. Connect a Male BNC connector to the female BNC connector on the rear panel of the MR 71.

## OPERATING INSTRUCTIONS

### STEREOPHONIC FM MULTIPLEX

1. Turn the MODE SELECTOR to STEREO AUTO.
2. Turn MUTING to IN.
3. Turn the FM TUNING dial to the desired station.

The TUNING indicator pointer should be in the black area of the tuning indicator meter. When the MPX STEREO indicator is lit, the station is broadcasting a 19KC carrier for multiplex stereo. The MR 71 will automatically switch to stereo Mode. If a station is broadcasting monophonic FM program, the MPX STEREO indicator will remain off and the tuner will automatically switch to Mono Mode.

4. Adjust the volume control to desired listening level.

If the fixed audio output jacks are used, the tuner volume control will not affect volume.

### MONOPHONIC FM

1. Turn the MODE SELECTOR to MONO to listen only to monophonic FM.

**Note:** If you wish to receive monophonic FM and have the MR 71 automatically switch to a stereo broadcast available on the same station set the MODE SELECTOR to STEREO AUTO.

2. Turn the MUTING to IN.
3. Turn the FM TUNING KNOB to the desired station. The TUNING indicator pointer should be in the black area in the center of the indicator.
4. Rotate the directional antenna for best reception as shown by the signal strength and multipath indicators.
5. Adjust the VOLUME control to desired listening level.

## ADJUSTMENTS

### MUTING THRESHOLD

---

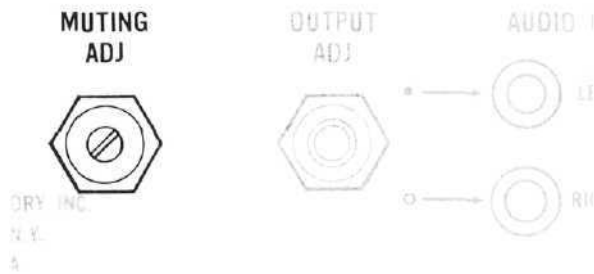

The MR 71 ultrasonic muting circuit suppresses all noise between stations. It suppresses all weaker stations not strong enough to override the background noise.

The muting threshold setting determines the strength of the signal which can be heard with muting in operation. The muting threshold is carefully adjusted to optimum at the factory using precision test instruments. Casual adjustment of the muting threshold is not recommended.

If it is necessary to adjust the muting threshold, use the MUTING ADJ control to the RIGHT (clockwise) to lower the muting threshold. This allows weaker stations to be heard with the MUTING IN SETTING. Turn the MUTING ADJ control to the LEFT (counterclockwise) to raise the muting threshold. This allows only the more powerful stations to be heard with the MUTING IN setting.

### DIAL PANEL LIGHT

Adjust the brightness of the dial panel lights by means of the PANEL LIGHT switch

on the tuner back panel. Set the switch to BRIGHT for maximum panel light. Set the switch to DIM for less dial light and extended lamp life.

### OUTPUT ADJUST

---

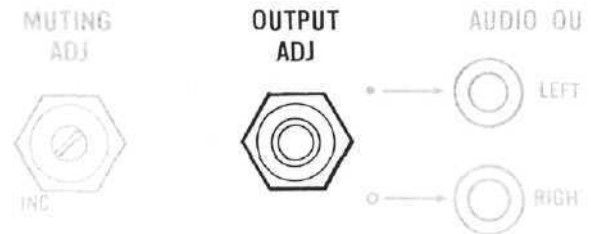

The dual concentric OUTPUT ADJ controls (on the tuner back panel) adjust the output volume level of the left hand pair of AUDIO OUTPUT JACKS. The center shaft of the control adjusts the left channel output. The outer sleeve of the control adjusts the right channel output.

Before making the adjustment, connect the left hand AUDIO OUTPUT jacks to the tuner inputs of the control preamplifier. Set the preamplifier selector to phono. Set the volume control to normal listening level for a stereo disc recording. Switch the preamplifier selector back to tuner. Set the MR 71 MODE SELECTOR to MONO. Tune in a local station. Tune the OUTPUT ADJ controls until the levels of both channels are equal, and equal to the volume level of the phono recording. You can now switch the preamplifier selector from the MR 71 to other program sources without readjusting the main volume control.











**McIntosh**  
**LABORATORY INC.**

2 CHAMBERS STREET, BINGHAMTON, N. Y.

Made in U.S.A.  
Phone-Area Code 607-723-5491